

MINI LC CONNECTOR (5.25mm PITCH TYPE)

The Mini LC Connector is designed with a narrow ferrule pitch to work with the Mini SFP (mSFP) transceiver. This accommodates the need of higher port densities provided by the transceivers without compromising performance. The change in pitch was introduced to create a more compact transceiver footprint. With this reduction, port density can be increased without changes to overall enclosure dimensions.

The MINI LC Duplex Connector looks virtually identical to standard LC Duplex connector distinguishable with its black Duplex clip and its 5.25mm pitch versus the 6.25mm used in standard LC Duplex connector.

CONNECTOR	FERRULE TYPE	HOUSING	BOOT TYPE	BOOT COLOR
916	LC Pre-Assembled	1 SM: Blue	2 2.0mm	1 White
	1 PC, 5.25mm Pitch	2 MM: Beige	Round Boot	
		5 MM OM3: Aqua		
		6 MM OM4: Heather Violet		

916 - 151 - 121 ORDER CODE example

Note: Other ferrule ID size are available
 SM 126µm SM 125µm MM 230µm MM 144µm

Features:

- Increase the density
- Extremely compact design
- Easy assembly
- Ferrule to ferrule pitch reduced from 6.25 to 5.25
- Same spec as the Standard LC Connector

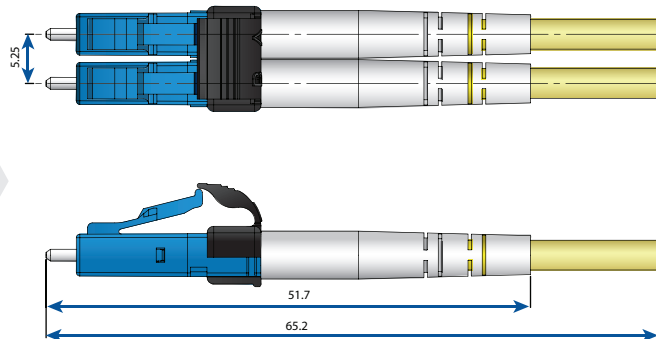

MINI LC Connector
 5.25mm Pitch

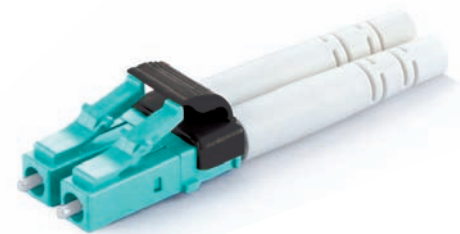

MINI LC 2.0mm
 Duplex Connector, Aqua

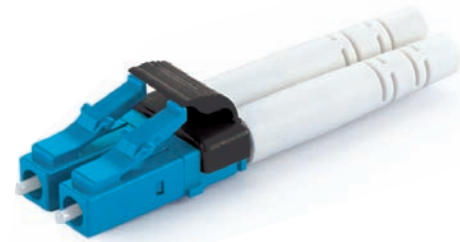

MINI LC 2.0mm
 Duplex Connector, Blue

LC CRIMP TOOL

CODE	CONNECTOR TYPE
CRT	701 LC/MU Dual Crimp Tool
	705 SC/LC 1.2mm Connectors

CRT - 701 ORDER CODE example



1 PC Connector (510 Series)

MU ONE PIECE CONNECTOR

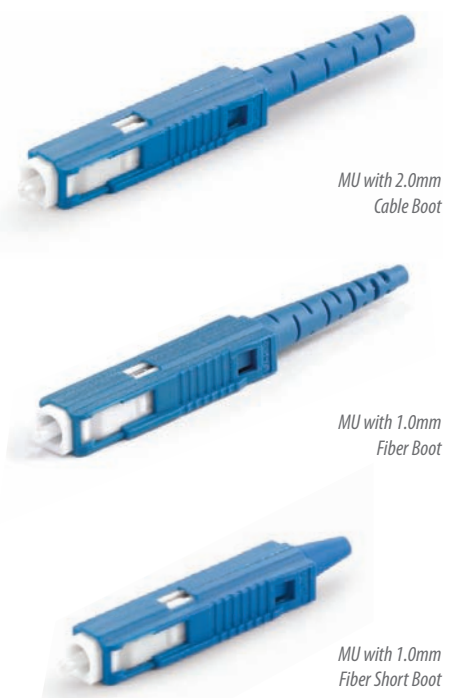

CONNECTOR	FERRULE TYPE	HOUSING	BOOT TYPE	BOOT COLOR
510 MU Connector	113 SM: 125µm	1 Blue	1 2.0mm Cable	1 Blue
	211 MM: 127µm	2 Black	2 1.0mm Fiber	2 Black
		3 Red	4 1.6mm Cable	3 Green
		4 Beige	5 1.0 Fiber Short	4 Red
		5 Brown		5 Gray
		6 Yellow		6 Yellow
		0 MU-J*		7 White
				8 Beige
				9 Lavender

510 - 113 - 519 ORDER CODE example

Note: Other ferrule ID size are available
SM 126µm SM 125.5µm

Features:

- NTT-MU hardware compatibility
- NTT & JIS compliance
- Pre assembled 1pc style
- Compact, pull-proof design
- One piece construction
- Tunable zirconia connector ferrule
- Corrosion resistant body
- UL-rated plastic housing and boot
- Universal Duplex Clip
- Low insertion loss & back reflection

Connector Kit (511 Series)

MU CONNECTOR KIT



CODE	FERRULE TYPE	HOUSING	BOOT TYPE	BOOT COLOR
511 MU Kit	xxx	5 Brown	1 2.0mm Cable	9 Lavender
		0 MU-J*	3 1.0mm Fiber Short Body	

511 - xxx - 519 ORDER CODE example

Note: 1. Custom configurations available upon request
2. Ferrule to be ordered separately

MU DUPLEX CLIP

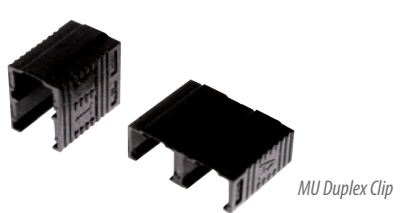

CODE	CLIP TYPE	BOOT COLOR
512 MU Kit	1 Vertical	12 Black
	2 Horizontal	15 Brown

512 - 215 ORDER CODE example

Note: Custom configurations available upon request

MU ADAPTER

MU Adapter

CODE	TYPE	SLEEVE
MUA	1 Simplex	ZA Zirconia
	2 Duplex	
	3 8-Port	

ORDER CODE example: MUA - 1 - ZA

Features:

- Compact design
- NTT-MU hardware compatibility
- NTT & JIS compliance
- High precision alignment
- Low insertion and return loss and back reflection*
- Corrosion resistance reflection

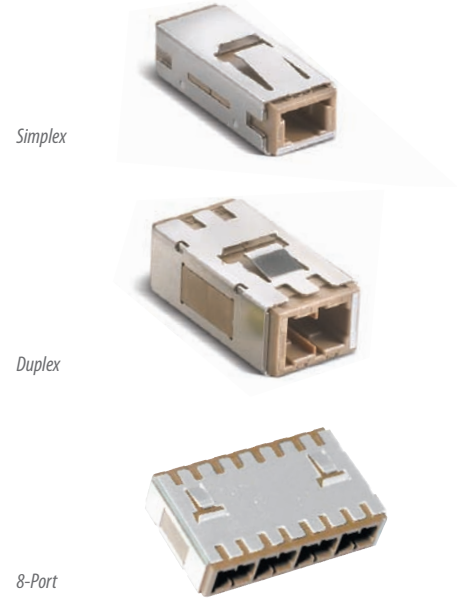

MU BACKBOARD AND PACKAGE HOUSING

MU Back Board

CODE	TYPE	HOUSING TYPE
MUB	2 Duplex	1 2.4mm Back Board Thickness
	8 8-Port	2 3.2mm Back Board Thickness
		3 Package Housing

ORDER CODE example: MUB - 2 - 1

Features:

- Compact design
- NTT-MU hardware compatibility
- NTT & JIS compliance
- High precision alignment
- Low insertion and return loss and back reflection*
- Corrosion resistance reflection

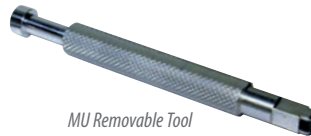
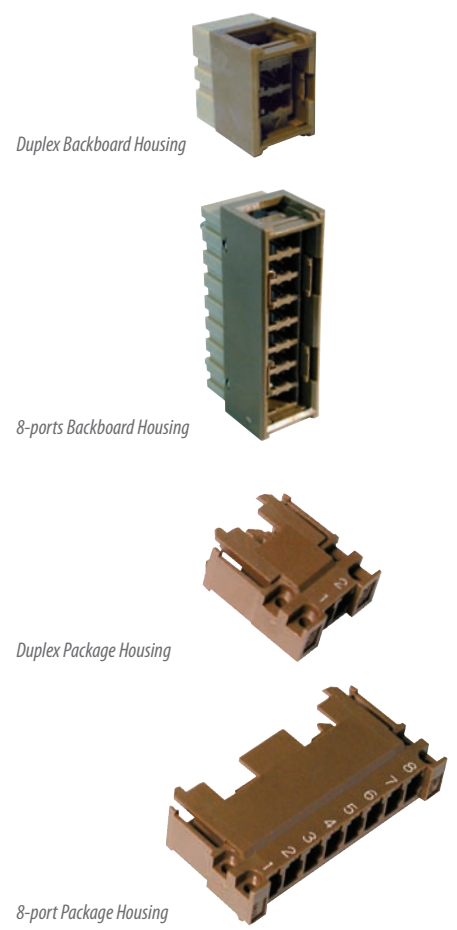

CODE	TYPE
MU Sleeve Holder	SH

ORDER CODE example: MU - SH

CODE	TYPE
MU Removable Tool	JRT

ORDER CODE example: MU - JRT