

# T.W.A.L. TRANSMISSION WITH APPLIED TENSILE LOAD

Ky Ly - Senior Staff Engineer

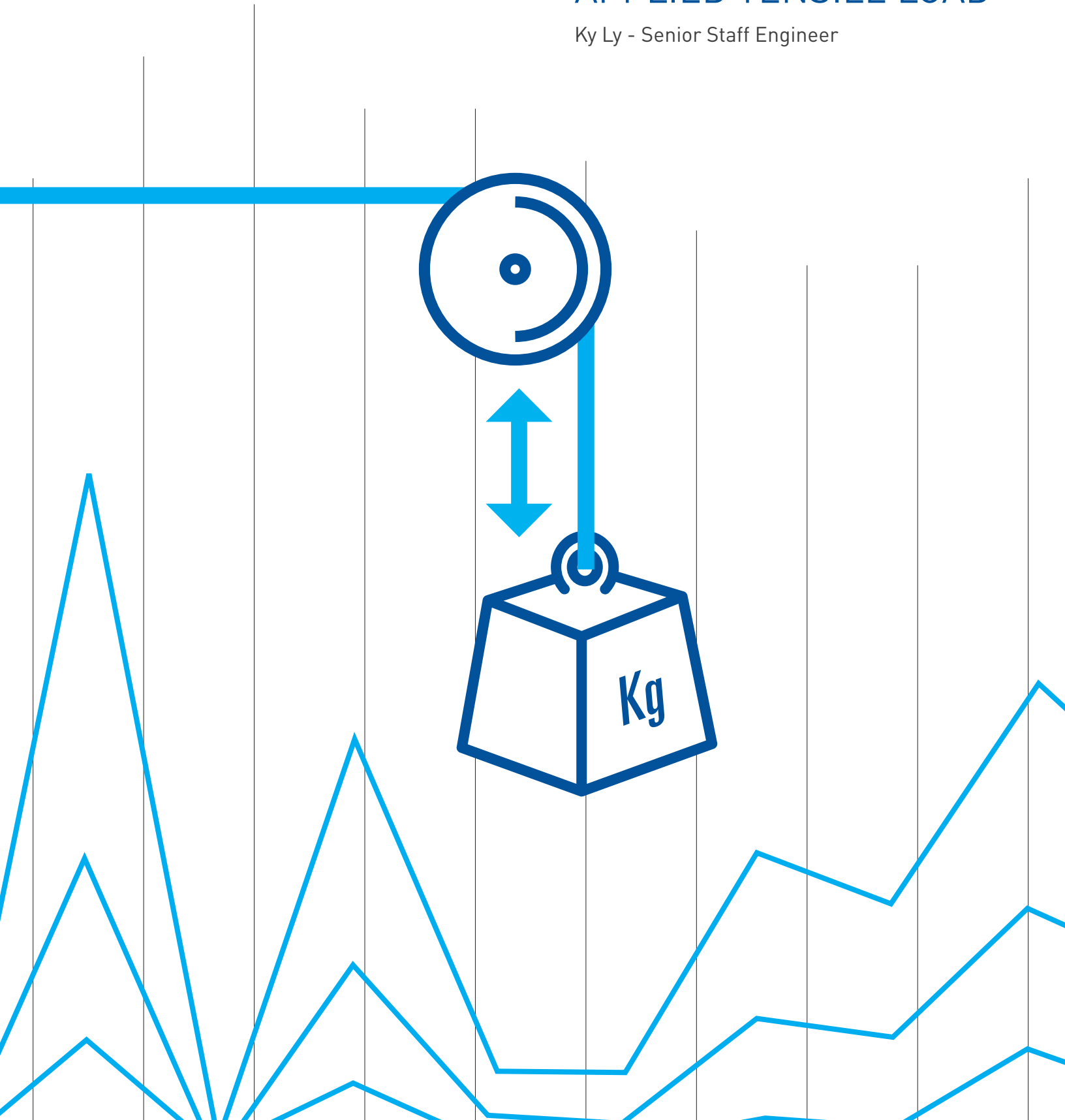

# T.W.A.L. TRANSMISSION WITH APPLIED TENSILE LOAD

## Contents

4	Introduction
4	Problem Statement
4	Telcordia GR-326-Core T.W.A.L. why does it matter?
5	What about Pre-angled or other short boots?
5	Solution
6	Summary
7	Supplemental Comparisons

ADVANCED COMPONENTS, INC.

cas  
T 1-888-32-SENKO  
T 1-858-623-3300  
mericas@senko.com

86-21-5830-4513  
6-755-2533-4893  
7-8725-9057  
o.com

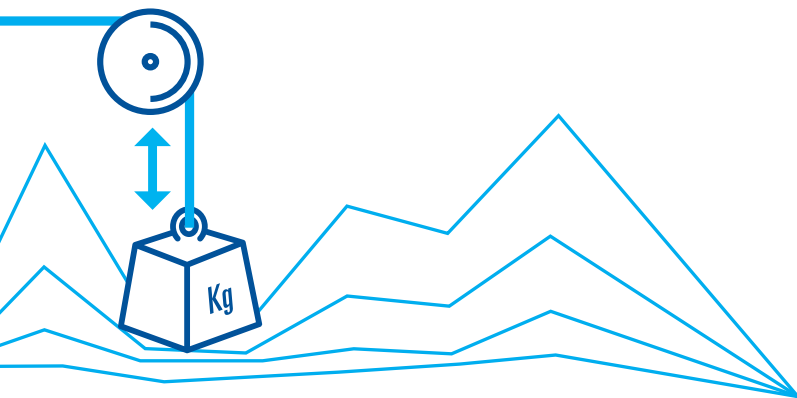

## Introduction

In the not so distant past, it was enough to be able to access the internet and desktop PCs or laptops, and watch TV on, well, on your TV. Now we can stream TV, movies and music to our TVs at our convenience, as well as to the plethora of mobile devices we at our disposal. On-demand services such as Netflix, iPlayer and Lovefilm have sprung up in recent years to provide us with all the media content we crave for, whenever we want it.

With Google's launch of Google TV and the unveiling of Samsung's, Sony's and LG's net enabled TVs powered by Google TV at this year's CES exhibition, not to mention the emergence of IPTV, Cloud gaming and storage, we are seeing a convergence of all these technologies and services into a single device in the home.

However, for such services and technologies to provide the better, faster, more responsive on-demand services that are required, an inevitable emphasis will be placed on not only greater bandwidth, but just as importantly, network stability. To provide this, evermore compact, high density enclosures are used in datacenters and street cabinets. This however, is easier said than done. Using fiber optic cables in confined spaces provide obstacles, critical to the system integrity of any server or network architecture.

## Problem Statement

Fiber optic cables do not take too kindly to being bent and crammed into tight spaces. In many cases it is not possible to organize long lengths of cable tidily to prevent excessive bending and strain. Long lengths of vertical cable used as interconnects between racks not only bend, but also applies tensile loading on the cable, causing macro bending, leading to degradation or loss of signal. This is much more than just an inconvenience, leading to down time, loss of revenue, and even critical data loss.

For use in a confined space, fiber optic cables must utilize a low macro bending sensitive fiber, supported by a well-designed strain relief boot must be used. Bend insensitive fibers allow the mathematical length of the boot to be shortened, but the boot design must be such that it can negate tensile loads on applied onto or by the cable in such a way to maintain signal integrity.

## Telcordia GR-326-Core T.W.A.L. why does it matter?

Random Telcordia GR-326-Core, section 4.4.3.5 T.W.A.L. is a live Insertion Loss test where varying tensile loads are applied at a series of angles, and the IL taken during the application of the loads. For example, with the connector held at 135° a 0.25kgf tensile load is applied, Insertion Loss shall not exceed 0.5dB.

Unlike taking measurements before and after applying the loads at different angles, this live testing more accurately replicates in-service use to ensure signal, and therefore, service integrity. This underlines compliance with Telcordia GR-326-Core, section 4.4.3.5 is not an option, it is a must for fiber optic cable assemblies targeted for use in confined spaces, and for them to do so the use of a well-designed, short strain relief boot is essential.

## TWAL test setup

Fig 1  
Load and Angle applied during test

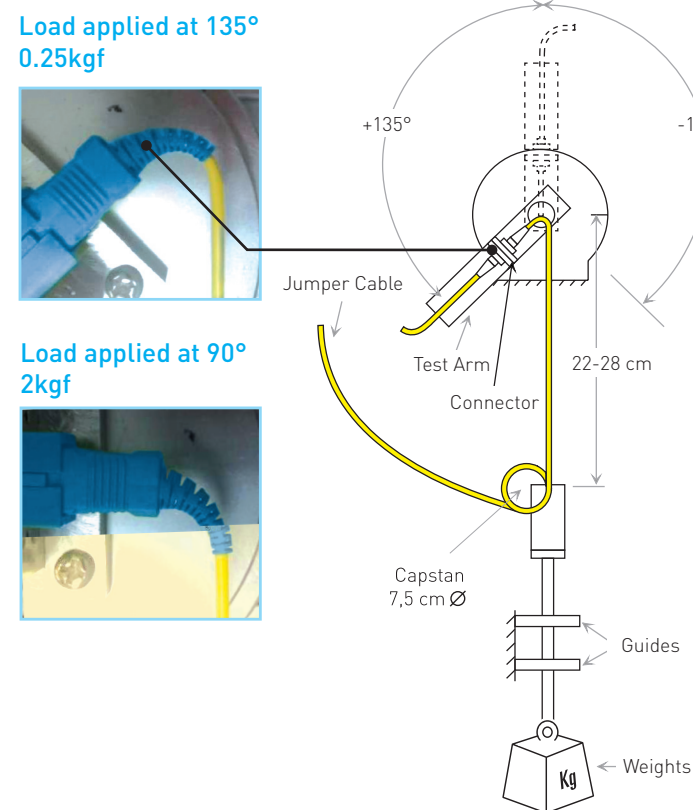

Fig 2  
This paper describes the benefits of SENKO's new Mini Boots in comparison to that of standard boots in the key area of Telcordia GR-326-Core, section 4.4.3.5 T.W.A.L. compliance.

Load	0°	90°	135°
<b>Media Type I (2mm or 3mm jacketed type)</b>			
0.25 kgf (0.55 lbf)	X	X	X
0.7 kgf (1.54 lbf)	X	X	
1.5 kgf (3.3 lbf)	X	X	
2.0 kgf (4.4 lbf)	X	X	
<b>Media Type II (900µm buffer type)</b>			
0.25 kgf (0.55 lbf)	X	X	X
0.7 kgf (1.54 lbf)	X	X	
<b>Media Type III (250µm bare fiber)</b>			
0.25 kgf (0.55 lbf)	X	X	
0.5 kgf (1.1 lbf)	X	X	

## What about Pre-angled or other short boots?

These are of course alternatives boots, however, they cannot be considered to be alternatives to the Mini Boots. They either are simply not able to comply with the T.W.A.L. testing or are too long for use in confined spaces.

## Solution

SENKO has designed a Mini Boot series using a different material than previous series of boots. Various designs and materials were tested during testing and selection processes. The final designs and material were decided after samples passed T.W.A.L. Jumper assemblies using Mini Boot and cables utilizing macro bending insensitive fiber easily passes Telcordia GR-326-Core, section 4.4.3.5. Transmission With Applied Tensile Load (T.W.A.L.) criteria. This combination has enabled SENKO to produce a boot, that when used with SENKO's current connectors, reduces overall connector length by up to 30%, ideally suited for use in confined enclosures.

## Summary

The SENKO Mini Boot, although much shorter, easily outperforms the conventional boot at all four wavelengths with all applied loads, especially with applied loads at 135°, where the attenuation is only a third of that of the conventional boot.

Although the weight of typical 2 meter LC 2mm and 3mm patchcords are only approximately 10g and 15g respectively, cable management systems will increase the tensile loading and bend the cable beyond 90°, highlighting the importance of applied load testing beyond 90°.

The importance of the of Mini Boot's performance at 1625nm cannot be overlooked. With the growing use of this wavelength, having cable assemblies able to pass T.W.A.L. at 1625nm in place will save countless hours of future down time and upgrade costs.

For Mini Boot and conventional boot comparison, please see the two graphs below.

### SENKO 2mm LC Mini Boot

Average IL loss with G657A1 (R10) fiber

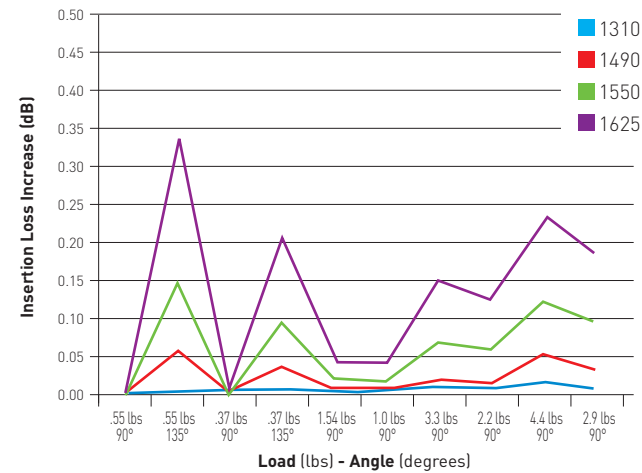

### Conventional 2mm LC boot

Average IL loss with G652.D fiber

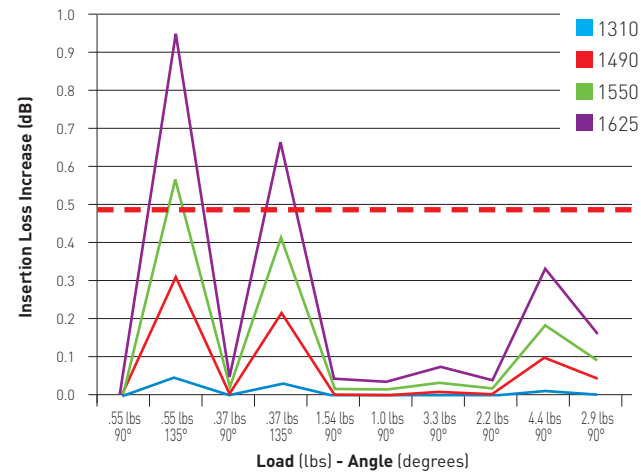

## Supplemental Comparisons

SENKO  
Mini Boots

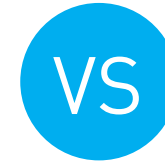

Competitor with  
conventional boots

### SENKO 2mm LC Mini Boot

Average IL loss with G657A1 (R10) fiber

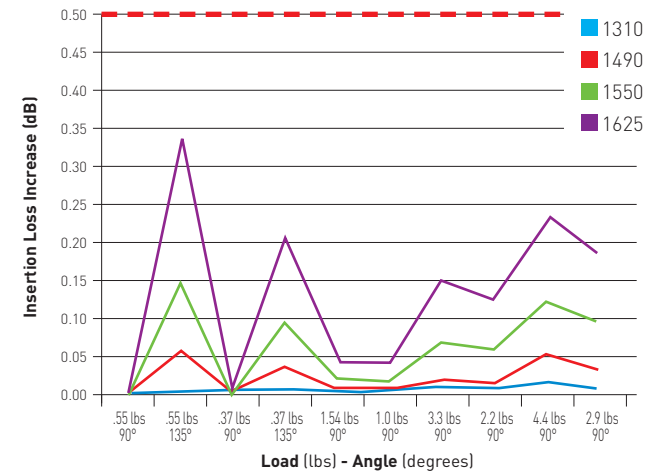

### Competitor 2mm LC

Average IL loss with G657A1 (R10) fiber

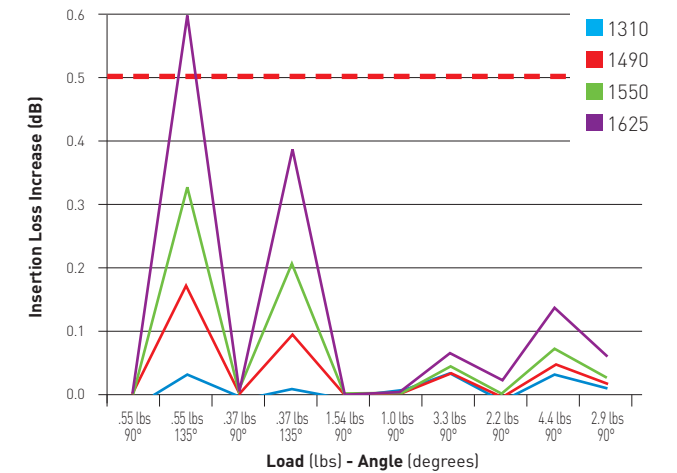

With the use of G657A2 (R7.5) fiber, the performance graph almost flat-lines for all wavelengths, for all applied loads at 90 and 135, highlighting the performance benefits of a combination of bend insensitive fiber and high quality strain relief boot. They also clearly illustrate bend insensitive fiber is not the only determining factor for T.W.A.L. compliance, the strain relief boot is also crucial. See graph to the right.

### SENKO 2mm LC Mini Boot

Average IL loss with G657A2 (R7.5) fiber

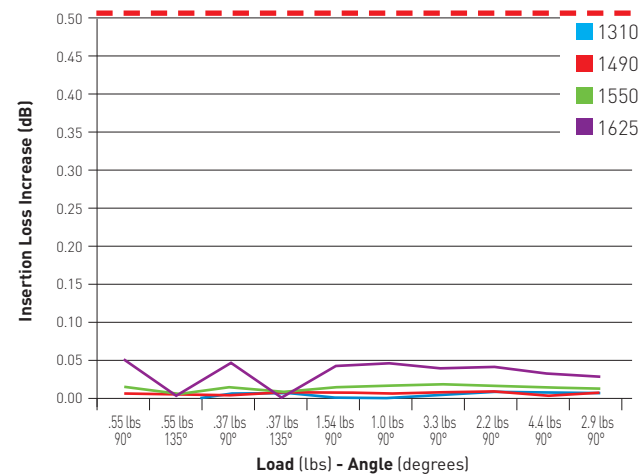

### SENKO 2mm SC APC

Average IL loss

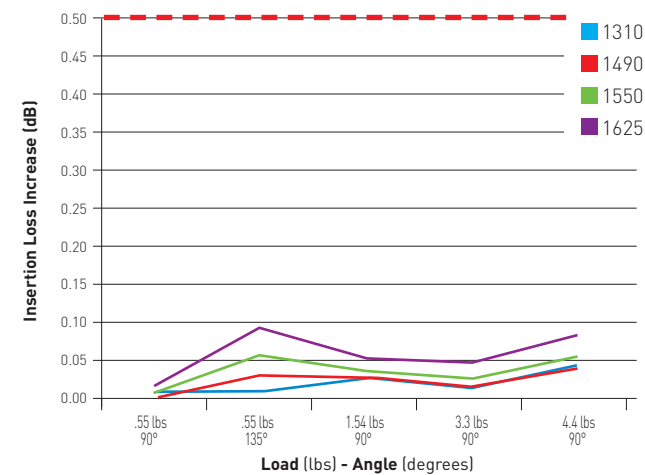

### Competitor 2mm SC APC

Average IL loss

